

Contents in this document may change without prior notice.
Please obtain the delivery specification for the latest design.



EM Series
5.7"
5VDC
Embedded Linux
Open Frame Panel Computer

EM8/EMG8

Model: EM8-205A7-0005-207 / EMG8-205A7-0005-207

Product Specification

DMC Co., Ltd.
<https://www.dush.co.jp/english/>

Table of Contents

1. Summary.....	3
2. Product Model.....	3
3. Packaged Contents.....	3
4. Specification.....	4
4-1 Functional specification.....	4
4-2 Display Specification.....	5
4-3 Touch Screen Specifications.....	5
4-4 General Specification.....	6
4-5 Environmental Specification.....	6
4-6 Installation Specification.....	6
4-7 Names of parts.....	7
4-8 External Interface.....	8
4-8-1 microSD card slot.....	8
4-8-2 Serial Interface (SIO1/SIO2).....	8
4-8-3 Ethernet.....	9
4-8-4 USB Host Interface.....	9
4-8-5 USB Device Interface.....	9
4-8-6 DIO Interface 1.....	10
4-8-7 DIO Interface 2.....	12
4-8-8 Power Connector.....	13
4-8-9 Battery Interface.....	13
4-8-10 Shipping setting switch.....	13
4-9 Linux OS Specification.....	14
4-9-1 Application software development environment.....	14
4-9-2 Embedded application.....	14
4-9-3 IS-APP.....	14
5. Installation.....	15
5-1 Installing condition.....	15
5-2 Mounting.....	16
5-2-1 Panel mounting.....	16
6. Product label.....	17
7. Compatible Standards.....	17
7-1 RoHS Directives.....	17
8. List of Option.....	18
9. Warranty.....	19
9-1 Warranty Period.....	19
9-2 Warranty Exceptions.....	19
10. Production Discontinuance.....	19
11. Others.....	20

Appendix : Outline drawing SM3-002022-12, SM3-002023-12

1. Summary

This specification describes the 5.7" panel computer.

Touch Screen line up is analog resistive and projected capacitive.

The panel computer will be referred to as EM8 hereinafter

2. Product Model

Part number	Specification			
	LCD size	Touch Screen	Power supply	HMI application
EM8-205A7-0005-207	5.7"	Resistive	5VDC	IS-APP *1
EMG8-205A7-0005-207		Projected Capacitive		IS-APP *1

*1 Please purchase development kit (SWDK-102), when using HMI application "IS-APP"

For details, please refer to the IS-APP startup guide

3. Packaged Contents

Package	Specification	Packing box dimensions
• EM8	10 pcs/box *1	457(W) × 295(D) × 151(H) mm

*1 : Maximum unit package : 10 units per box

4. Specification

4-1 Functional specification

Item		Specifications	
		EM8-205A7-0005-207 / EMG8-205A7-0005-207	
CPU		NXP i.MX6UL 528MHz (ARM Cortex-A7 single core)	
RAM		DDR3-SDRAM 256MB	
ROM		NAND Flash 512MB	
Battery Backup SRAM		128KB	
Interface	Serial	SIO1	RS232C : 1CH (5-pin nylon connector)
		SIO2	RS422/485: 1CH (6-pin nylon connector)
	Ethernet		10BASE-T/100BASE-TX : 1CH
	microSD Card *1		microSD/SDHC card slot : 1CH
	USB host *2		USB2.0 : 1CH (TYPE-A connector) USB devices that can be used : keyboard, mouse(HID Class), USB memory (Mass Storage Class)
	USB device		USB2.0 : 1CH (miniTYPE-B connector)
	DIO 1		Input 6 points (Non-insulated LVCMOS level input) Output 4 points (Non-insulated Open drain output)
	DIO 2		VCC output 1 points Output 8 points (Non-insulated Open drain output [limited resistance 1KΩ included])
	Buzzer		On board
	RTC *3		RTC with a battery backup Error at the time of backup :±65 seconds/month (Conditions: ambient temperature 25°C)

*1 Does not guarantee accurate operation for all SD memory cards available in the market.

*2 Does not guarantee accurate function for all USB devices available in the market.

*3 Above chart shows RTC with battery back-up embedded on the EM8.

EM8 normally uses timer inside of the CPU for time display. If time according to specification is needed, please refer to RTC built-in the EM8.

When using in system where time error becomes a problem, please set to correct time on a regular basis.

4-2 Display Specification

Item	Specifications	
	EM8-205A7-0005-207 / EMG8-205A7-0005-207	
Display	Type	5.7" TFT LCD
	Resolution	640(W) × 480(H)
	Color	65,536 colors
	Backlight	LED (not replaceable)
	Brightness	400cd/m ²
	Backlight brightness adjustment	Adjustable in 8 levels
	Backlight life *1	70,000 hours average

*1 Time until brightness declines by 50% from the initial value at maximum brightness in ambient temperature of 25°C.

4-3 Touch Screen Specifications

Item	Specifications	
	EM8-205A7-0005-207	EMG8-205A7-0005-207
Type	Analog resistive	Projected Capacitive
Input Type	Finger	Finger
Multi-touch	1 point	2 points *1
Operating life	Continuous typing (finger input) : 10 million times	Continuous typing (finger input) : 50 million times

*1 Application for two point simultaneous input must be created by customer.

Note: Touch screen operations will become unstable depending on the installation environment due to its characteristics. In order to use it correctly, perform calibration for sensitivity sensor of touch screen when building into a device. Also, if at any time the touch screen operations become unstable due to changes in the setting environment or installation, perform sensitivity sensor calibration.

If there is moisture on the touch screen surface, it may not operate properly.

When moisture is detected on the surface, please wipe it dry before use.

4-4 General Specification

Item		Specification	
		EM8-205A7-0005-207 / EMG8-205A7-0005-207	
Power	Rated voltage	5VDC	
	Voltage tolerance	5VDC±5%	
	Power consumption*1	3.6W or under (Typ. 1.9W)	
	FG Connection	FG (Frame GND) and SG (Signal GND) are connected internally	

*1 Power consumption of the unit only. Please consider the power consumption of the USB device when using the USB.

Note: When gentle power source is used for rising and falling of power, it may not operate properly.

Also, when rebooting EM8, leave it off for a while after turning off; do not turn the power back on immediately. It may not start up accurately.

4-5 Environmental Specification

Item	Specification
Ambient operating temperature (Inside cabinet and display side)	0°C to 55°C
Ambient storage temperature	-20°C to +80°C
Ambient operating humidity	10%RH to 90%RH (Non-condensing. Wet-bulb temperature is 39 °C or less)
Ambient storage humidity	10%RH to 90%RH (Non-condensing. Wet-bulb temperature is 39 °C or less)
Dust	0.1mg/m ³ or under (Conductive dust is prohibited)
Corrosive Gas	Corrosive gas Prohibited
Environment	Pollution Degree 2, Indoor use
Pressure resistance	800hPa to 1114hPa (Altitude up to 2000m)
Vibration resistance	IEC61131-2(JIS B 3502) compliant 5Hz to 9Hz Single amplitude 3.5mm 9Hz to 150Hz Fixed acceleration 9.8m/s ² X,Y,Z directions for 10times(100min.)

4-6 Installation Specification

Item	Specification	
	EM8-205A7-0005-207	EMG8-205A7-0005-207
Grounding	Functional grounding : D type ground	
Structure	Open frame	
Cooling	Natural cooling	
Weight	Approx, 375g	Approx,390g
External Dimensions	164(W) × 107.7(H) × 33.1(D) mm	164(W) × 107.7(H) × 33.4(D) mm
Outline drawing	SM3-002023-12	SM3-002022-12

4-7 Names of parts

■ Back : EM8-205A7-0005-207 / EMG8-205A7-0005-207

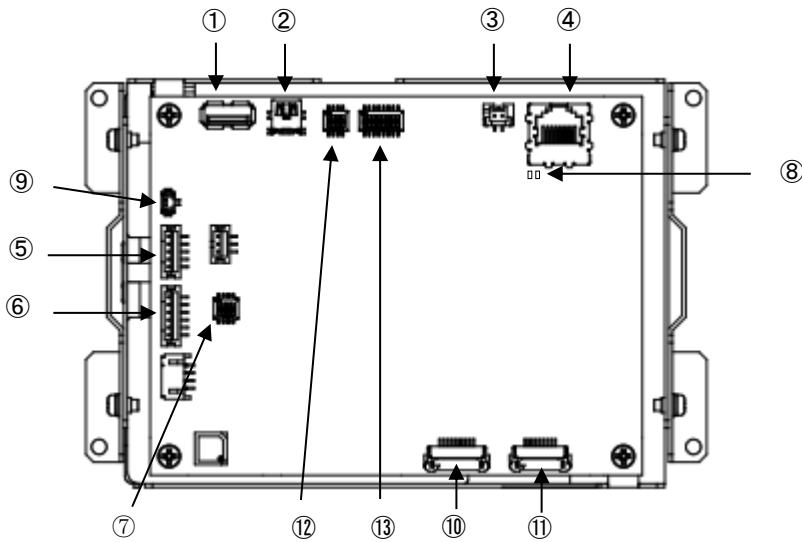

- | | |
|-----------------------|---------------------------------|
| ① USB Host | ⑧ Status LEDs for Ethernet Port |
| ② USB Device | ⑨ Battery Input |
| ③ Power Input | ⑩ DIO 1 |
| ④ Ethernet | ⑪ DIO 2 |
| ⑤ Serial Port (SIO1) | ⑫ Shipping setting switch1 |
| ⑥ Serial Port (SIO2) | ⑬ Shipping setting switch2 |
| ⑦ SIO2 setting switch | |

■ Bottom : EM8-205A7-0005-207 / EMG8-205A7-0005-207

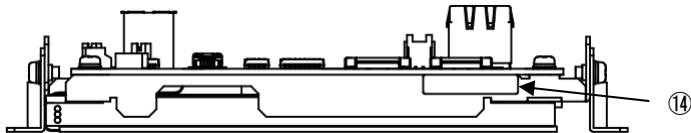

- ⑭ Product label

■ Top : EM8-205A7-0005-207 / EMG8-205A7-0005-207

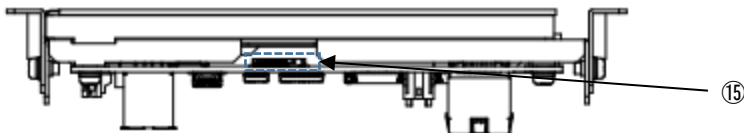

- ⑮ microSD Card slot

4-8 External Interface

4-8-1 microSD card slot

Connector : microSD card slot (Push-in/Push-out method)

Corresponding media : microSD/SDHC memory card

Maximum capacity : 32GB

4-8-2 Serial Interface (SIO1/SIO2)

(1)Serial port (SIO1) : RS232C

Connector : Nylon connector

Recommended connector : B5B-PH-SM4-TB (JST)

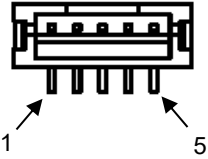
PIN No	Signal	Schematic
1	RXD	
2	TXD	
3	GND	
4	RTS	
5	CTS	

(2)Serial port (SIO2) : RS422/485

Connector : Nylon connector

Recommended connector : B6B-PH- SM4-TB (JST)

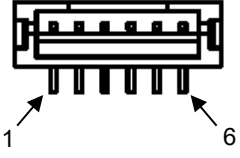
PIN No	Signal		Schematic
	RS422	RS485	
1	TX+	DATA+	
2	TX-	DATA-	
3	GND	GND	
4	RX+	(DATA+) ^{*1}	
5	RX-	(DATA-) ^{*2}	
6	GND	GND	

*1 It is connected to pin 1 inside the product.

*2 It is connected to pin 2 inside the product.

RS422/485 setting enable to change by SIO2 setting switch

Default setting at shipment is RS485 Terminating resistance enabled

PIN No	RS422	RS485	Detail
1	ON/OFF		ON: Terminating enable / OFF: disable
2	OFF	ON	RS422/485 setting
3	OFF	ON	
4	OFF	ON	

4-8-3 Ethernet

Ethernet : 10BASE-T/100BASE-TX

Connector : RJ-45

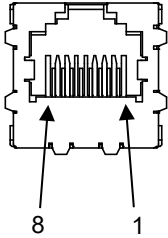
PIN no	Signal	Schematic
1	TX+	
2	TX-	
3	RX+	
4	NC *1	
5	NC *1	
6	RX-	
7	NC *1	
8	NC *1	

*1 NC is not connected

Status LED

GREEN : LINK/ACT

YELLOW : SPEED

*Status LED is located on board

Compatible cable: Above Category 5

4-8-4 USB Host Interface

Interface : USB2.0

Connector : Type-A connector

Maximum supply current : 0.5A

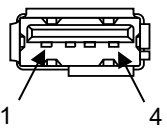
PIN No	Signal	Schematic
1	USB_VCC	
2	D-	
3	D+	
4	GND	

4-8-5 USB Device Interface

Interface : USB2.0

Connector : Type-B Mini connector

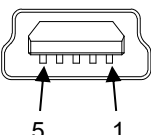
PIN No	Signal	Schematic
1	USB_VCC	
2	D-	
3	D+	
4	NC*1	
5	GND	

*1 NC is not connected

4-8-6 DIO Interface 1

Connector : FFC (1mm pitch lower contact)

Type : 00-6200-107-032-800+ (Kyocera Elco)

PIN	Signal	Input / output Specifications	Interface Circuit	Schematic
1	DOUT 12 (SCAN 4)	Non-insulated open drain output (negative logic) Voltage:5V[5.5V(MAX)]*1 Current:12mA(MAX)*1*2		
2	DOUT 11 (SCAN 3)			
3	DOUT 10 (SCAN 2)			
4	DOUT 9 (SCAN 1)			
5	DIN 6 (RET 6)	Non-insulated 3.3V*1 (LVCMOS level) input (positive logic)		
6	DIN 5 (RET 5)			
7	DIN 4 (RET 4)			
8	DIN 3 (RET 3)			
9	DIN 2 (RET 2)			
10	DIN 1 (RET 1)			

*1 Note : If it is used beyond the upper limit of the specified value, it may lead to a failure.

*2 Note : The current value per port. Use with a total of 40mA or less.

Applicable cable drawing

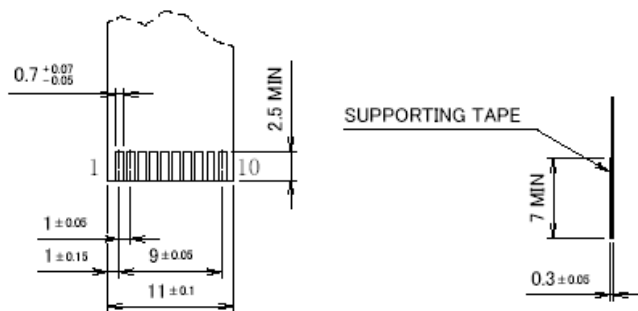

Switch of the matrix circuit, as shown in the diagram below, can be connected.

* Do not press multiple switches simultaneously. It may result in incorrect input.



4-8-7 DIO Interface 2

Connector : FFC (1mm pitch lower contact)

Type : 00-6200-097-032-800+ (Kyocera Elco)

PIN	Signal	Input / Output Specification	Interface circuit	Schematic
1	VCC	5V output 200mA(MAX) ^{*1}	Output +5V in the board	
2	DOUT 1	Non-insulated open drain output		
3	DOUT 2			
4	DOUT 3	(negative logic)		
5	DOUT 4	Voltage:5V[5.5V(MAX)] ^{*1}		
6	DOUT 5	Current:5mA ^{*2}		
7	DOUT 6	*Limited resistance		
8	DOUT 7	included 1KΩ		
9	DOUT 8			

*1 Note : If it is used beyond the upper limit of the specified value, it may lead to a failure.

*2 Note : The current value per port.

Applicable cable drawing

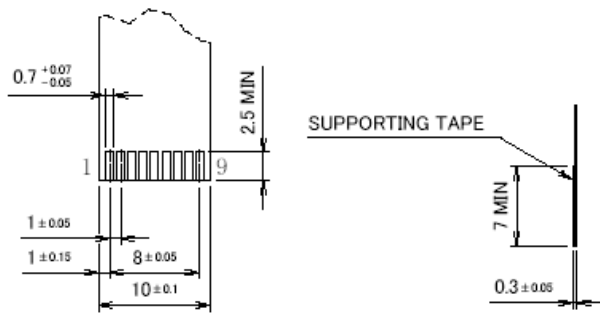

LED of the LED circuit, as shown on the diagram below, can be connected.

By generating output to the DIO number shown below, the LED can be turned ON or OFF.

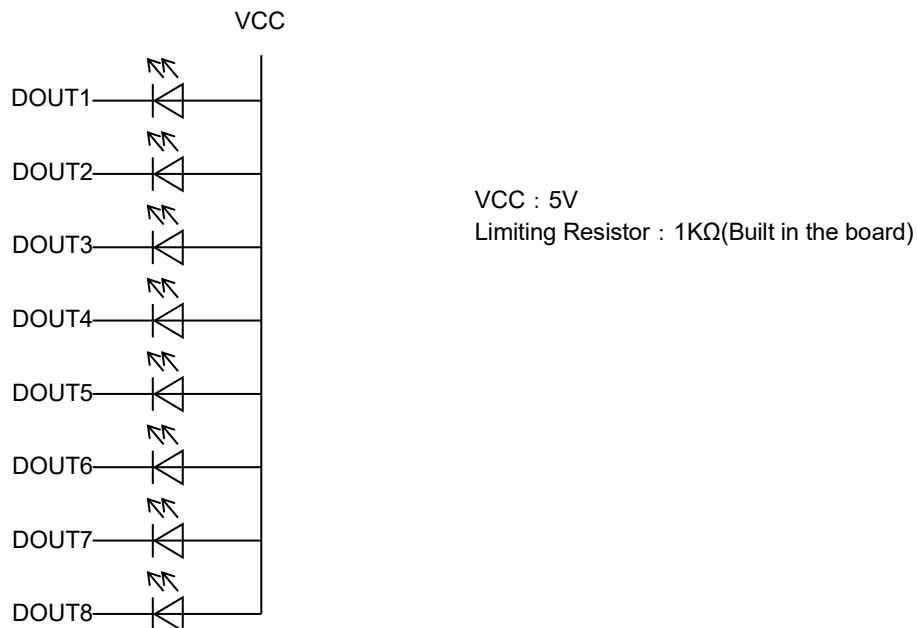

4-8-8 Power Connector

Interface : 5VDC IN

Connector : Nylon connector

Recommended connector : BM02B-PASS-1-TFT (JST)

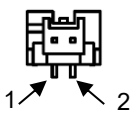
PIN	Signal	Schematic
1	+5VDC	
2	GND	

4-8-9 Battery Interface

Use the primary battery as the battery. Use the one with a nominal voltage of 3VDC.

Do not apply a voltage higher than 3.6VDC.

The backup current is TYP 60 μ A.

Connector : Nylon connector

Recommended connector : DF13C-2P-1.25V(21) (Hirose electric)

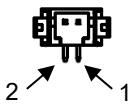
PIN	Signal	Schematic
1	+	
2	-	

* Recommended battery type: CR2032WK11 (capacity 220mA / h)

* Primary batteries with a nominal voltage of 3VDC can be used with batteries other than those listed above.

4-8-10 Shipping setting switch

This is a factory default switch. Don't change the switch settings.

EM8 factory settings

Shipping setting switch1

No.	1	2	3	4
Set	ON	ON	OFF	OFF

Shipping setting switch2

No.	1	2	3	4	5	6	7	8
Set	OFF	OFF	ON	ON	OFF	ON	ON	OFF

4-9 Linux OS Specification

This describes the Linux OS embedded in the EM8.

For details, please refer to the EM series software development manual.

We can provide the software development environment (DVD).

Please contact us via e-mail for the DVD.

4-9-1 Application software development environment

Qt application recommended

4-9-2 Embedded application

Specification of Linux shows the following table

Item	specifications	
Glibc version	2.23	
Implementation software	Qt5.7.1	GUI tool kit
	PCMan File Manager	File manager
	uim	Japanese input method
	anthy	Conversion engine
	GTK+	GIMP Toolkit library
	bash	Bash shell
	busybox	Program that saves Linux base command as one file
	udhcpc	DHC client
	gdbserver	Gdb debugger that can connect from host
	ntpcclient	Time synchronization by NTP
	Lighttpd	Web server: php and chi compatible
	x11	X Window system
	x11vnc	VNC server/client
	LXTerminal	Terminal emulator
	ALSA	Audio mixer
	emg-setting	EMG setting tool
	florence	Screen keyboard
	leafpad	Text editor
openssh	SSH server	
libmodbus	Modbus library	

* For details, please refer to "EM series software development manual".

4-9-3 IS-APP

EM8 is able to implement the function of InfoSOSA(IS-APP) HMI application.

Please purchase "Development Kit(SWDK-102) when uses IS-APP.

For details, Please refer to "IS-APP start up guide"

5. Installation

5-1 Installing condition

- When mounting the EM8 to panels, be sure to have enough room for inserting and removing microSD cards, cables, and mounting brackets.
 - Please install EM8 between EM8 and structures or parts considering the specification temperature and ensure the ventilation.
 - Be sure that the ambient operation temperature (0°C to 55°C) and the ambient humidity (10%RH to 90%RH. Wet-bulb temperature is 39°C or less) are within their designated ranges.
- “Ambient operation temperature” indicates both the display side and inside of cabinet where the EM8 will be installed.

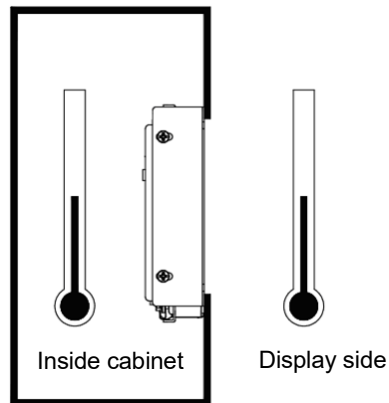

5-2 Mounting

5-2-1 Panel mounting

Below is the panel opening dimension example for when applying sheets and etc. to the surface by opening the entire touch screen surface.

Design the chassis accordingly to the actual installing method.

* Diagram from the front side of panel (panel thickness: 1.6mm or less)

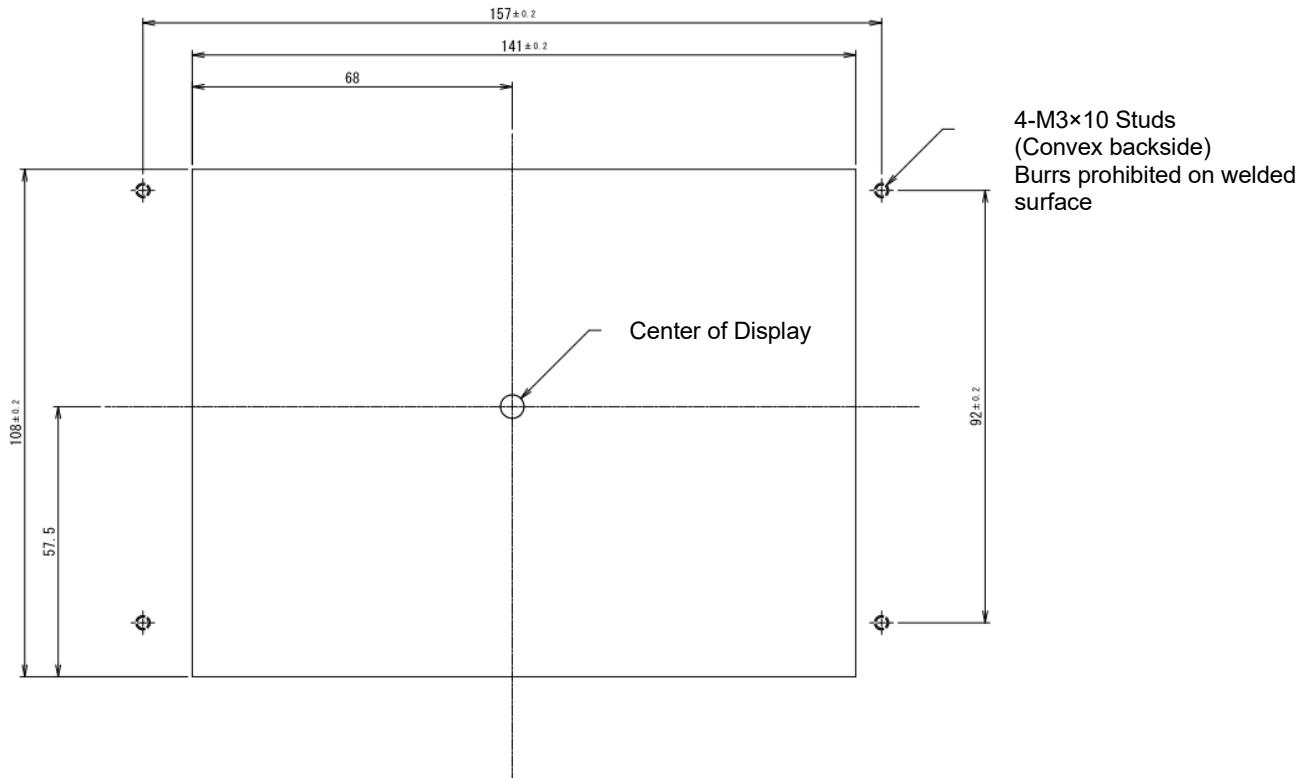

6. Product label



The above is an image of the Product label design

The product will be labeled with the following information

- Model name : Print the model of the product you purchased.
- Serial number : Print the 10-digit control number assigned by us.
- Revision : Print the alphabet (One letter of the A to Z) according to the latest shipping version.

7. Compatible Standards

7-1 RoHS Directives

This product is RoHS Directive of EU complaint

8. List of Option

■ Development Kit for IS-APP

Model	Description
SWDK-102	5VDC Power unit InfoSOSA Development Kit Data Download Guide *1

*1 This is needed when using InfoSOSA(IS-APP) application.

■ Serial communication cable

Model	Description
ISCBL-S02-001	RS232C Cable [Nylon connector 5P - Dsub (2000mm)]
ISCBL-S03-001	RS232C Cable [Nylon connector 5P - cut end (500mm)]
SWHC-T2-001	RS422 Cable [Nylon connector 6P - cut end (500mm)]
SWHC-T3-001	RS485 Cable [Nylon connector 6P - cut end (500mm)]

■ Power supply cable

Model	Description
ISCBL-S01-001	Power supply Cable [Nylon connector 2P - cut end (500mm)]

9. Warranty

9-1 Warranty Period

The warranty period is limited to 12 months (1 year) from the date of shipment. Warranty for any repair needed to the same repaired part of the same product is three months. Any defects that occur upon normal use under conditions specified herein will be repaired (factory repair) free of charge.

Any defected parts under proper use will be examined by the supplier and replaced by the new parts if the defect is considered to be caused by the supplier.

The replacement is subject to be included in the next lot.

9-2 Warranty Exceptions

You will be liable for all repair fees even within the warranty period for any conditions listed below:

- (1) Any malfunctions, defects, and/or damages that occurred during transport, transfer, or mishandling by the user after delivery
- (2) Any malfunctions, defects, and/or damages caused by natural or man-made disaster.
- (3) Any malfunctions and damages caused by static electricity.
- (4) If the product is used under any condition, in any environment, or by any method other than those specified in the specifications, catalogs, manuals, notes, and/or other documents.
- (5) Any replacement of consumables.
- (6) Any malfunctions, defects, and/or damages caused by associated equipment and/or usage of inappropriate consumables and media.
- (7) If the product is repaired, remodeled, modified, or disassembled by a party other than DMC.
- (8) If the product cannot be identified by a serial number.
- (9) Any malfunctions, defects, and/or damages that are to have been caused on your behalf.

This warranty covers only the product itself. No warranty is provided for damages, on-site repair, or replacement resulting from product failure.

All damaged parts are subject for replacement and freight will be charged.

10. Production Discontinuance

In the event of production discontinuance, an announcement will be made on our guidance six months prior to the last possible order reception date.

11. Others

If you have comments or questions, please feel free to contact us.

North South America area

✉ technical-global@dush.co.jp

Asia Pacific area

✉ technical-global-asia@dush.co.jp

Europe, Middle East, Africa area

✉ technical-global-eu@dush.co.jp

FAQ

 www.dush.co.jp/english/support/faq/

2nd Edition April 2024

DMC Co., Ltd.

Office hours: 9:00 - 17:00 weekdays (JST)

(except Saturdays, Sundays, national holidays, and year-end and New Year holidays)

URL: <https://www.dush.co.jp/english/>

This product and document are protected by the copyright law.

Photocopying, duplicating, reproducing, and modifying of this product or document in part or by whole is prohibited.

Copyright(C) 2024 DMC Co., Ltd. All Rights Reserved

寸法許容差 TOLERANCE	
呼び寸法	
L ≤ 3	±0.4
3 < L ≤ 6	±0.48
6 < L ≤ 10	±0.58
10 < L ≤ 18	±0.7
18 < L ≤ 30	±0.84
30 < L ≤ 50	±1.0
50 < L ≤ 80	±1.2
80 < L ≤ 120	±1.4
120 < L ≤ 180	±1.6
180 < L ≤ 250	±1.85
250 < L ≤ 315	±2.1
315 < L ≤ 400	±2.3
400 < L ≤ 500	±2.5

SYM	改訂日 DATE	改訂内容 DESCRIPTION	ページ PAGE	担当 DESIGNED
	2018.05.21	新規図面登録	—	S. Yoshimoto
△	2020.03.23	Serial No. Label 削除	—	S. Takada
△	2024.02.15	表題欄社名変更、Insulation area、TP VIEWING AREA追加	—	S. Takada

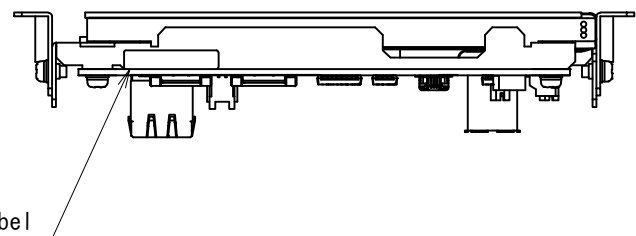
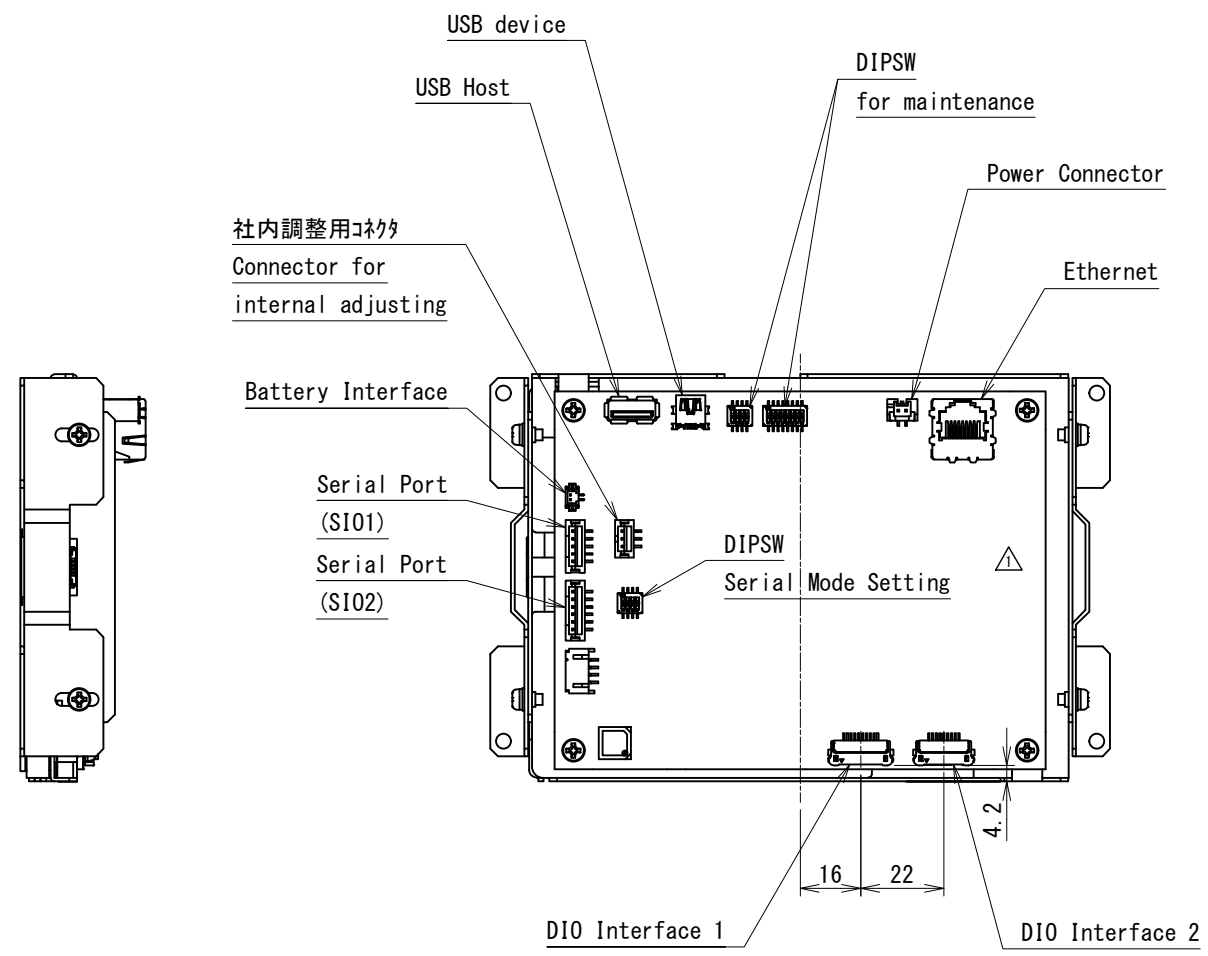
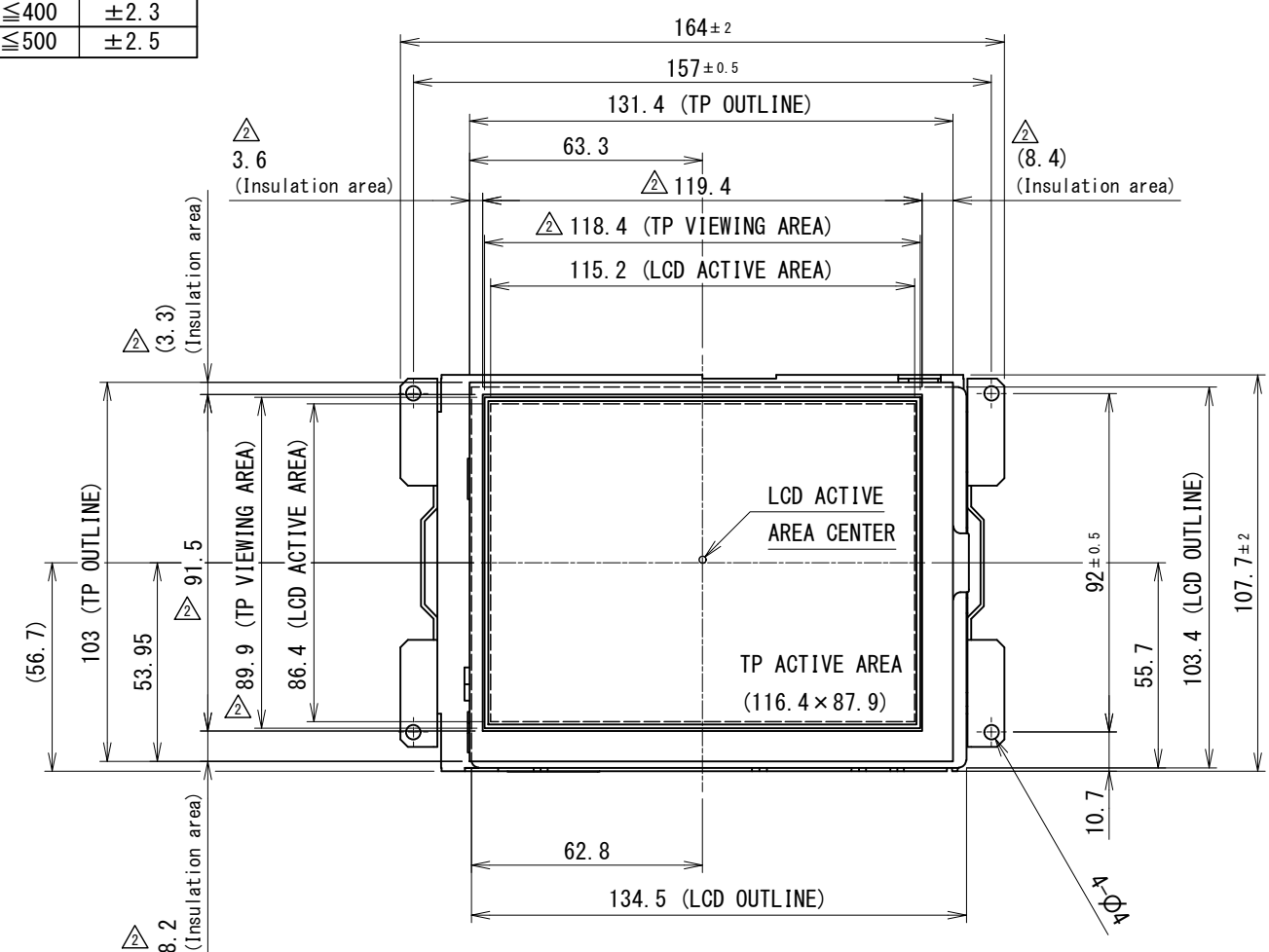
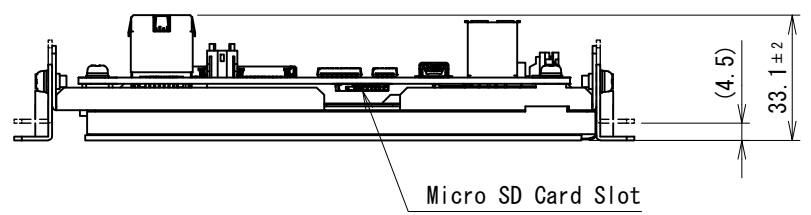

NOTES

1. 指示なき寸法公差は一般寸法公差とする。
Tolerance shall be of general dimensional tolerance unless specified otherwise.

2. 社内調整用コネクタは、お客様での使用はございません。
Connector for internal adjustment: cannot be used by customer.

製図日 ISSUED	2024.02.15	部署 SECTION	Technical Dept.	尺度 SCALE	CAD登録名 CAD FILE NAME	17K001-4_EM8-5_OUTLINE	RoHS対応品 RoHS compliant
承認 APPROVED		検図 CHECKED		1:2	製品名 MODEL	EM8-205A7-0005-XX7	
		製図 DRAWN		単位 UNIT	図名 TITLE	OUTLINE	ページ PAGE 1 / 1
		設計 DESIGNED		mm	図番 DWG No.	SM3-002023-12	
T. Okada			S. Yoshimoto	S. Takada	S. Takada		
DMC Co., Ltd.				A3			

寸法許容差 TOLERANCE	
呼び寸法	
L ≤ 3	±0.4
3 < L ≤ 6	±0.48
6 < L ≤ 10	±0.58
10 < L ≤ 18	±0.7
18 < L ≤ 30	±0.84
30 < L ≤ 50	±1.0
50 < L ≤ 80	±1.2
80 < L ≤ 120	±1.4
120 < L ≤ 180	±1.6
180 < L ≤ 250	±1.85
250 < L ≤ 315	±2.1
315 < L ≤ 400	±2.3
400 < L ≤ 500	±2.5

SYM	改訂日 DATE	改訂内容 DESCRIPTION	ページ PAGE	担当 DESIGNED
	2018.05.21	新規図面登録	—	S. Yoshimoto
△	2020.03.23	Serial No. Label 削除	—	S. Takada
△	2024.02.15	表題欄社名変更	—	S. Takada

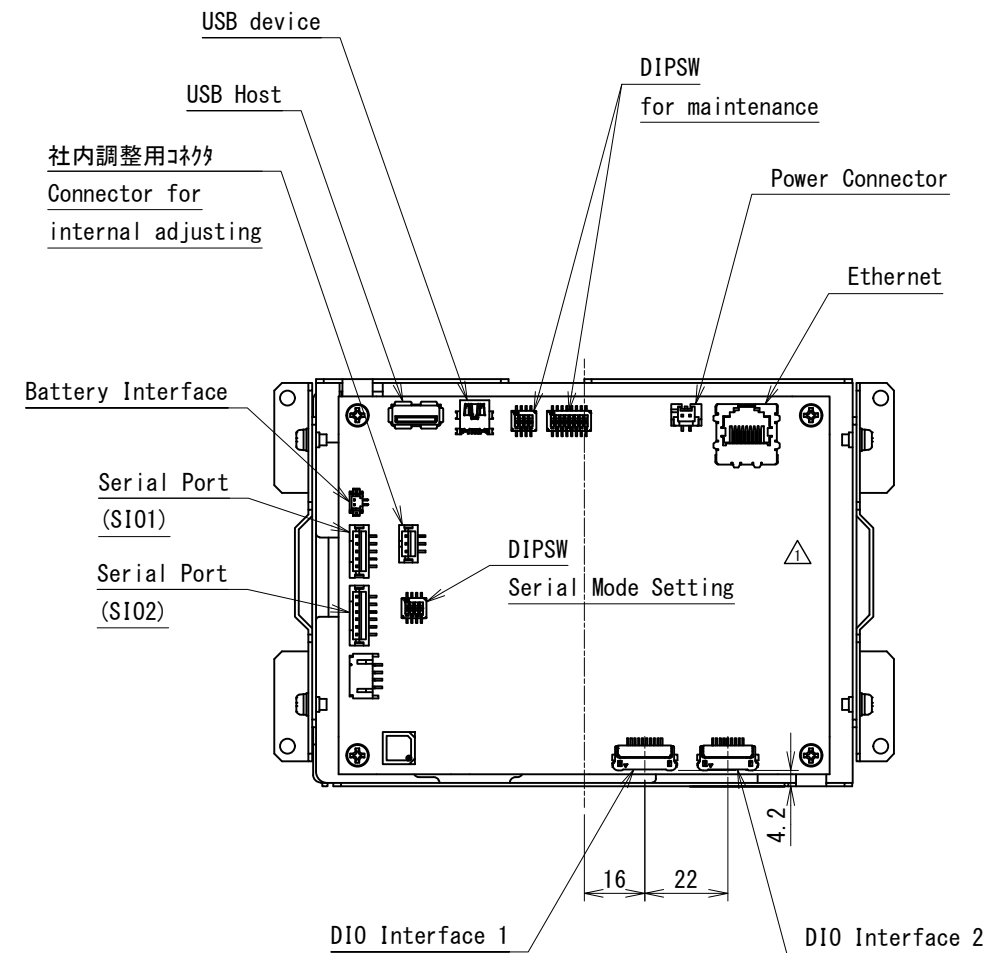
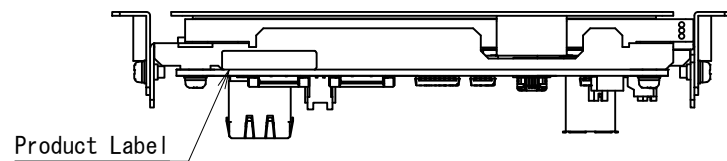
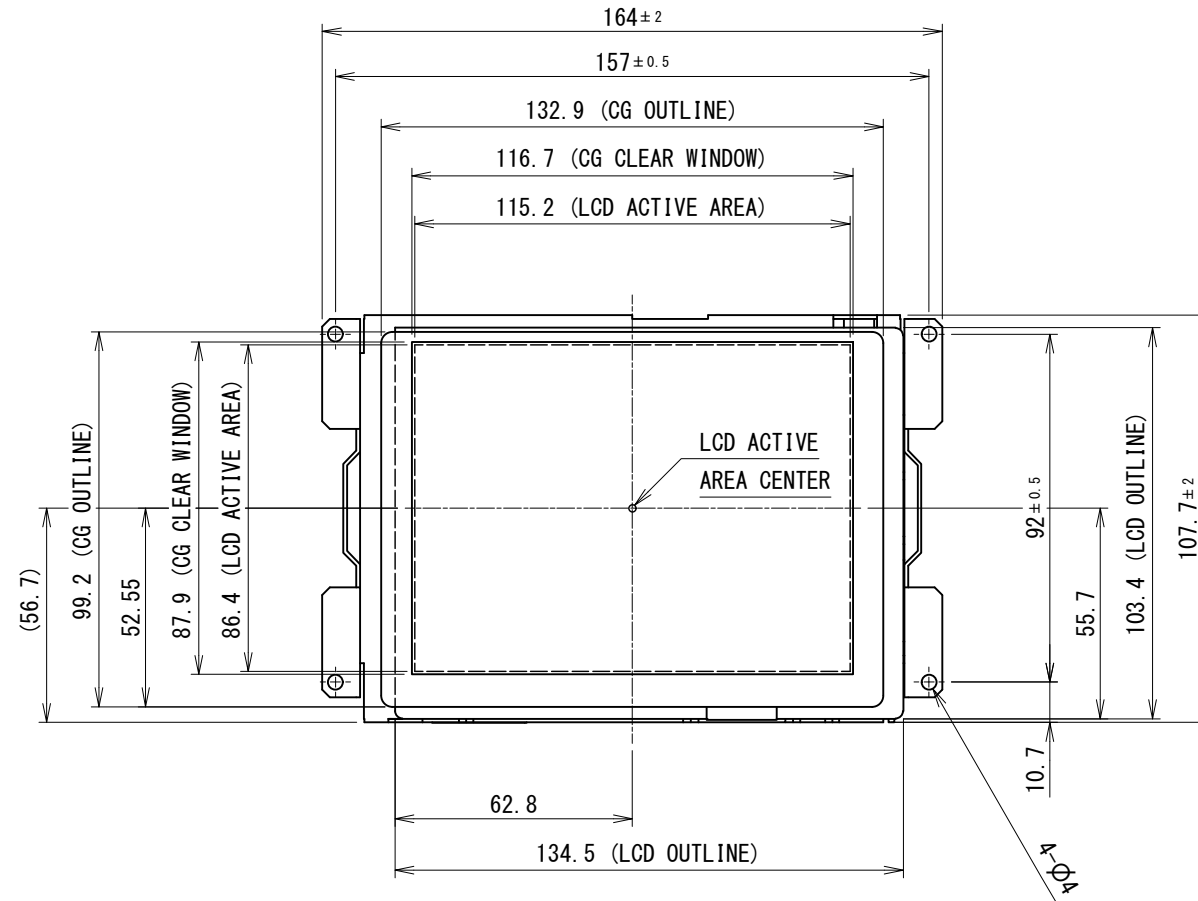
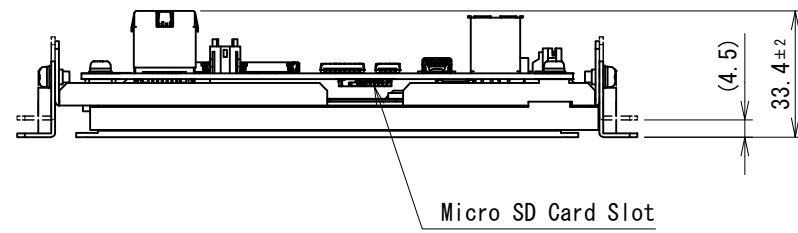

NOTES

- 指示なき寸法公差は一般寸法公差とする。
Tolerance shall be of general dimensional tolerance unless specified otherwise.
- 社内調整用コネクタは、お客様での使用はございません。
Connector for internal adjustment: cannot be used by customer.

製図日 ISSUED	2024, 02, 15	部署 SECTION	Technical Dept.	尺度 SCALE	CAD登録名 CAD FILE NAME	17K001-3_EMG8-5_OUTLINE	RoHS対応品 RoHS compliant
承認 APPROVED		検図 CHECKED		1:2	製品名 MODEL	EMG8-205A7-0005-XX7	
		製図 DRAWN		単位 UNIT	図名 TITLE	OUTLINE	ページ PAGE 1 / 1
				mm	図番 DWG No.	SM3-002022-12	
T. Okada			S. Yoshimoto	S. Takada	S. Takada	DMC Co., Ltd. A3	